

DANIEL®
NITROGEN LOADED LIQUID
CONTROL VALVES
PRODUCT GUIDE

Series 700



DANIEL®
Decades Proven. Field Chosen.™

NITROGEN LOADED RELIEF / BACK PRESSURE VALVES

Overview

The Daniel Series 700 (Models 762, 763, 765, 766 and 767) nitrogen loaded relief / back pressure control valves are specifically designed to regulate and control maximum pipeline pressures or to maintain a minimum back pressure in a system. They have proven to be reliable, rugged and very responsive in controlling pipeline surges and pressures. The Daniel Models 762, 763, 765, 766 and 767 nitrogen loaded relief / back pressure control valves are not pilot operated.

They incorporate an integral oil reservoir mounted on the external surface of the valve cylinder head, which upon installation, is partially filled with a light oil. Nitrogen under pressure is then applied to the reservoir. The oil is a moveable barrier between the nitrogen and the valve piston. This insures that nitrogen gas does not permeate the piston seals which would result in nitrogen consumption and the need to constantly replenish the system. A major benefit of the valve design is that all internal parts, including cylinder, piston and seat ring are removed as a cartridge assembly which keeps your line connections intact.

Applications

- Back pressure control
- Pipeline pump station by-pass
- Pipeline pressure and surge relief
- By-pass pressure control

Features and Benefits

- Modular construction
- No diaphragms or stuffing boxes
- Linear control characteristics
- Exceptionally fast response speed
- Positive shut-off
- High flow capacity
- Balanced piston design
- No pilot controls
- Can pass dirty or viscous products
- Screwed seat rings on all sizes
- No consumption of nitrogen gas



Principles of Operation

The Daniel Models 762, 763, 765, 766 and 767 control valves are normally closed and open on increasing inlet pressure. The basic valve is of the balanced piston operated design. Pressure applied to the inlet side of the piston is equally transmitted to the spring side of the piston. When the line pressure on the inlet side exceeds the gas pressure plus the pressure exerted by the spring, the moveable barrier of oil compresses the gas and the valve opens. As line pressure falls below set point, the gas pressure, added to the spring pressure, closes the valve and it remains closed as long as gas pressure is greater than the line pressure. Opening and closing speeds are controlled by a check valve mounted to the internal surface of the cylinder head as shown in Figure 1.

Opening speed is relatively unrestricted which results in very fast opening speed. Closing speed is controlled by the fixed orifice in the check valve.

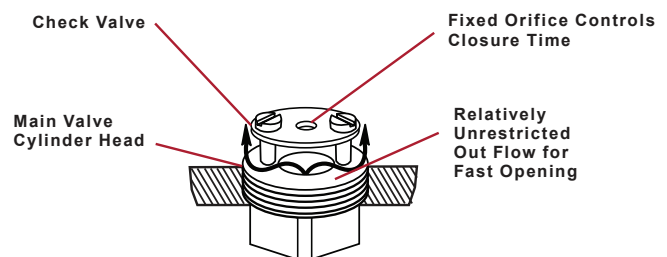

Figure 1: Check Valve

Oil Reservoir

The Oil Reservoir is supplied with two (2) sight gauges. In a closed position, the oil is visible only at the lower sight gauge. Should oil be visible in the upper sight gauge, this indicates line product is leaking into the reservoir or that the valve is open. If no oil is visible in the lower sight gauge, this indicates the reservoir oil is leaking into the product stream.

Oil Specifications

Use a light weight non-detergent oil between 5-30 Centipoise based on climate conditions of user.

The oil to fill the reservoir, nitrogen tank, pressure switch and other interconnecting pieces is to be supplied by the customer.

Opening / Closing Speed

The opening speed of the valve is virtually unrestricted. Closing speed is standard at three (3) seconds from a full open position, based on gas pressure being 25 psi (1,724 kPa) above line pressure. The fastest closure is limited to 0.5 seconds at 1,500 psi (10,342 kPa) differential pressure to protect the piston and seat ring. For closure speeds longer than three (3) seconds, the orifice size can be changed to match customer requirements. It should be noted that the calculated closing speeds are a function of the viscosity of the oil in the reservoir. Typical valve opening times are illustrated in Figure 2.

Pressure Switch

The valve will open any time gas pressure is less than line pressure. A pressure switch is recommended in the gas supply line to the valve for alarm actuation should gas pressure decrease below an acceptable operating level.

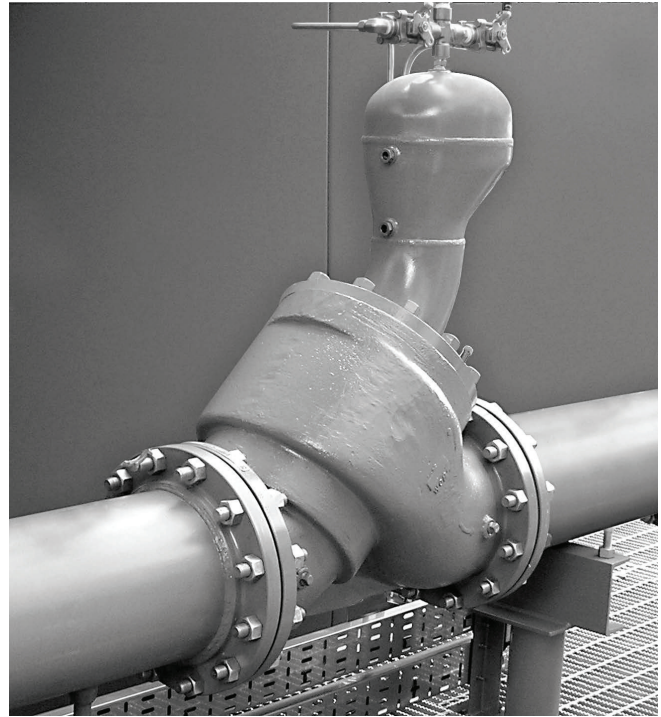

Horizontal Pipeline Installation

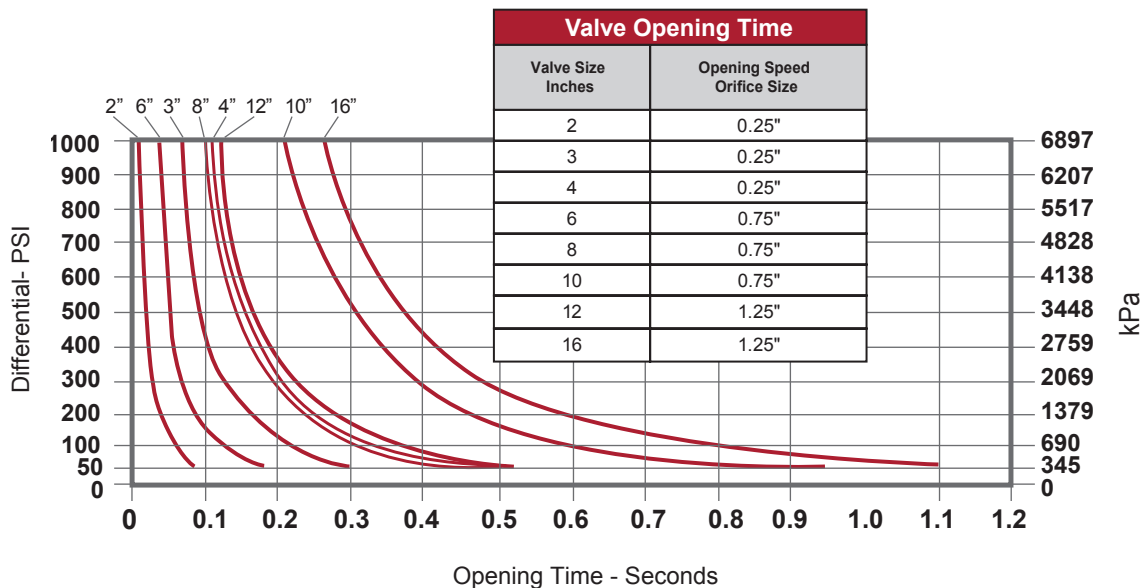

Figure 2: Typical Valve Opening Time

Gas Plenum Tank Installation and Sizing

The gas plenum should be buried underground to keep the gas at a constant temperature. Thermal expansion, caused by increases in temperature, will change the relief set point.

The effective volume of the gas plenum decreases as the valve opens by an amount equal to the piston displacement. The size of the gas plenum determines the percentage that the pressure relief set point will change as the valve opens. For example, a 12" valve piston displacement is 554 cubic inches from a closed to an open position. Thus, when fully opened, an equal amount of gas is contained in a volume that is decreased by 554 cubic inches. From Boyles Law, we can see the proportional increase in pressure as: $P_1V_1 = P_2V_2$. For example, a 12" valve piston displacement is 554 cubic inches from a closed to an open position.

Before the gas tank is sized, determine:

1. Set point (PSI)⁽¹⁾
2. Valve size
3. Allowable over-pressure (PSI) ⁽¹⁾ (typically 10%).

Gas Plenum Sizing Formula

$$V_1 = \frac{\left[PD \left(\frac{P_2}{P_1} \right)^{0.709} \right]}{\left[\left(\frac{P_2}{P_1} \right)^{0.709} - 1 \right]}$$

P_1 = Valve required set pressure, valve closed

P_2 = Maximum allowable overpressure, valve open

V_1 = Total Gas Volume (gas chamber and volume behind main valve piston)

PD = Volume displacement of main valve piston

Exponent = 0.709 derived from K factor of Nitrogen (1.41).

No consideration is given to the volume of gas contained in tubing, fittings and the top portion of the valve itself.

Volume Displacement (Main Valve Piston)			
Valve Size	Cubic Inches	Valve Size	Cubic Inches
2"	3.7	8"	165
3"	12.6	10"	347
4"	20	12"	554
6"	66	16"	1,207

Example:

(12" Valve, Set point 640 psi and Over-pressure is 40 psi)

$$P_1 = 640 \text{ psi set point required, minus 4 psi spring load plus } 14.7 \text{ psi (adjustment to absolute)} \\ = 650.7 \text{ psi}$$

$$P_2 = 680 \text{ psi maximum allowable over-pressure, minus 6 psi spring load plus } 14.7 \text{ psi (adjustment to absolute)} \\ = 688.7 \text{ psi}$$

$$V_1 = \text{Unknown}$$

$$PD = 554 \text{ in}^3$$

$$1 \text{ U.S. Gallon} = 231 \text{ cu. in.}$$

$$V_1 = \frac{576.74779}{0.041061} = 14,046.121 \text{ in}^3$$

$$V_1 = \frac{14,046.121}{231} = 60.80 \text{ U.S. Gallons (Tank Volume)}$$

NOTE: Valve is fitted with light piston spring which provides:

- 4 psi Preload with valve closed
- 6 psi Preload with valve open

This 4 and 6 psi Preload must be subtracted from P_1 & P_2 , respectively, to arrive at actual gas pressure.

Conditions assume adiabatic compression.

⁽¹⁾ Must be provided by customer

Applications

Back Pressure Control

The Model 762 is ideally suited for back pressure control and minimum pressure drop. When line pressure exceeds the gas pressure, the valve will open and follow the CV curve for pressure loss.

Typical applications for minimum back pressure control requirements are illustrated in Figure 3.

- Reference API Chapter 5 for minimum back pressure requirements of turbine and ultrasonic meters.
- On the end of a pipeline or any point along the pipeline where the upstream pressure is subject to drop below minimum requirements.
- Discharge of centrifugal pumps to maintain maximum efficiency and to start against a closed valve.

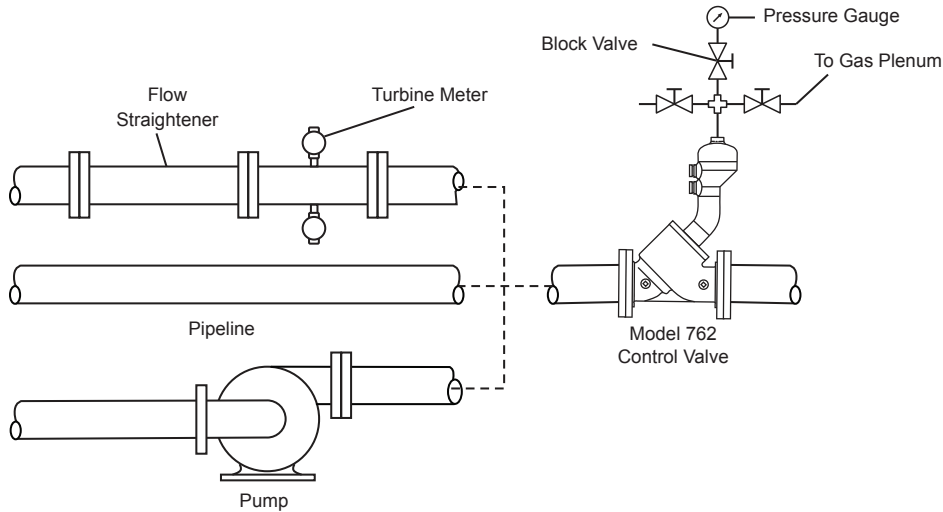

Figure 3: Back Pressure Control

Pipeline Pump Station By-Pass

Most pipeline have booster pumps at intervals along the pipeline. If a pump station is shut-down, it must be by-passed or the entire pipeline is subject to being shutdown. The Model 766 control valve, when installed as shown in Figure 4, will automatically open and by-pass the pump station when line pressure exceeds set point.

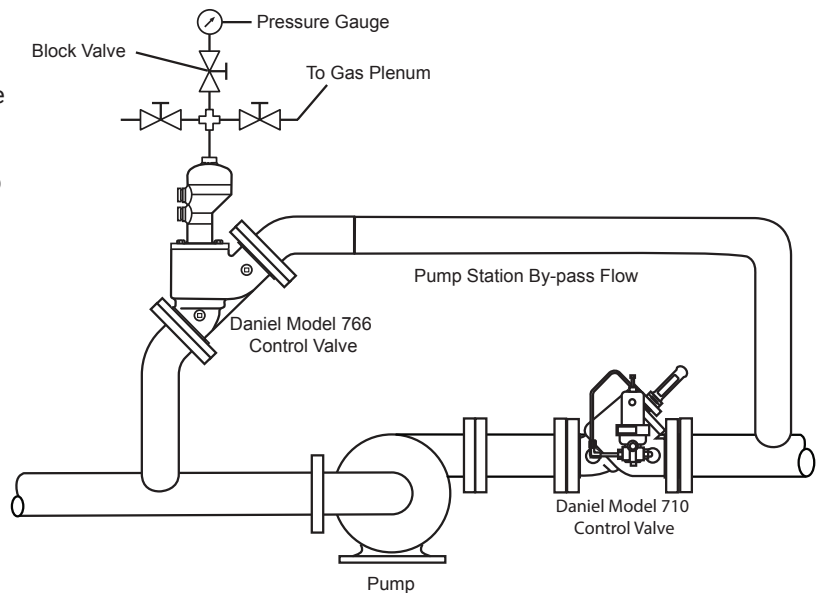

Figure 4: Pipeline Pump Station By-Pass

Pipeline Pressure and Surge Relief

Product movement by pipeline requires over-pressure protection. Response time to pressure rise is very critical. Many times a pilot operated or a conventional direct operated spring biased relief valve cannot react fast enough to limit surge pressure to a desirable level. The Model 762 will respond timely to relieve the volume of product necessary to decrease pipeline pressure to or below set-point. The installation shown in Figure 5 is very common in pipeline applications.

The schematic also shows the installation of a 45° in-line position valve design that keeps the piston alignment vertical. This distributes the weight of the piston equally and gives equal resistance to piston O-ring movement. Horizontal or vertical installation is also available. Whether installed at 45°, horizontally, or vertically with flow traveling up, the oil reservoir is in a vertical position. The type of installation must be specified on the order. Installing the valve in a vertical line with flow traveling down is not recommended.

Normal causes of surges and excess pressure

- Inadvertently closing a main line valve
- Closing a main line valve too fast
- Pump startup
- Stopping a pump with potential reverse flow
- Failure of a pipeline booster pump. In addition, the following factors can become very important with pipeline aging which reduce the maximum surge pressure the pipeline can withstand.
- Wear from product movement
- Internal and external corrosion
- Frequency and amplitude of surge and shock pressures

By-Pass Pressure Control

The Model 762 is suited for constant pump by-pass control to regulate pump discharge pressure. In this application the valve will also control surges. (Reference Figure 5).

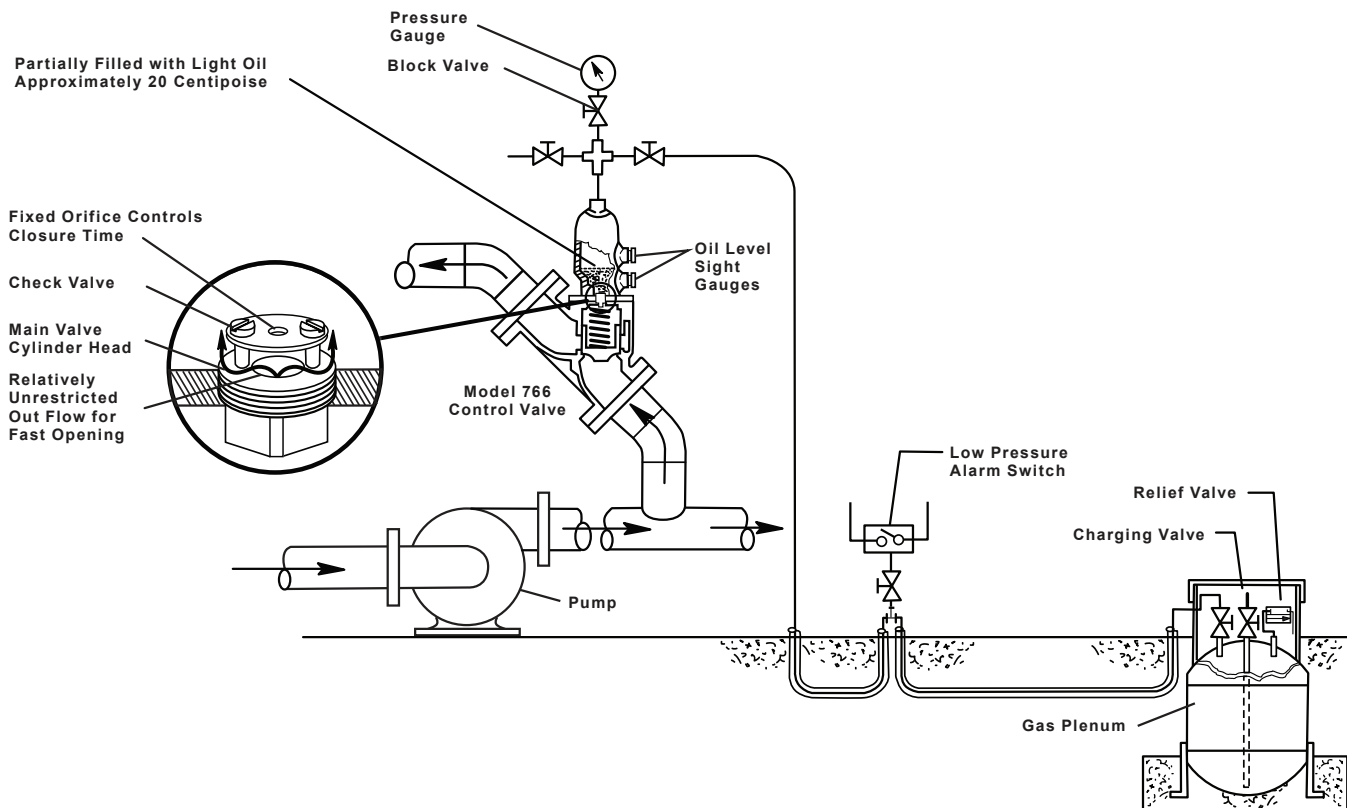

Figure 5: Excess Pressure and Surge Relief or Pump By-Pass Control

Nitrogen System Panel

A nitrogen control panel may be advantageous if there are large variations in ambient temperature or if it is not practical to bury the nitrogen plenum underground.

The control panel can be used to provide a precise output which is used to regulate the set point of the gas loaded relief valve.

The Nitrogen Supply Cylinders shown in Figure 6 below are used as a source of nitrogen and the control panel will use this to replenish the nitrogen pressure within the valve anytime it falls below the desired set point. Conversely if the set point at the valve is higher than the desired set point, the control panel will relieve the excess pressure from the valve.

Since the Daniel valve does not consume nitrogen, unlike competitive valves, the need to adjust nitrogen is normally due to changes in pressure due to ambient temperatures.

The nitrogen set point pressure is measured using a pressure transmitter, which can be transmitted to a remote control room. The system nitrogen set point is field adjustable by authorized personnel. Daniel Measurement and Control can furnish a complete system that will include the surge relief valve, inlet / outlet piping, nitrogen control panel, supply cylinders and the plenum. The system is carefully designed, engineered and assembled onto a structural skid with a lifting facility (as shown below in Figure 6).

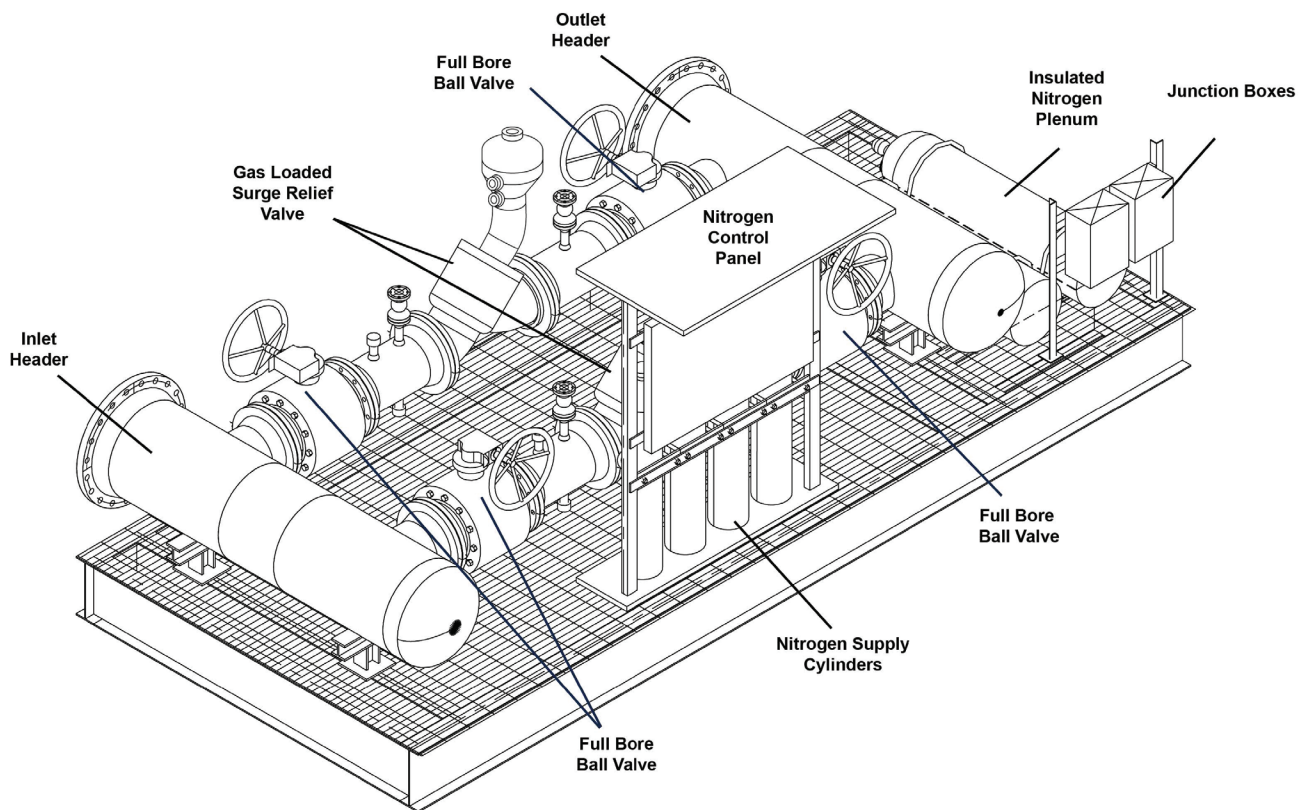

Figure 6: Surge Relief System with Nitrogen Panel and Plenum

STANDARD SPECIFICATIONS

Please consult Daniel if your requirements are outside the specifications noted below. Other product and material offerings may be available depending on the application. For world area locations and contact information, refer to the back page of the data sheet.

Materials of Construction

Main Valve Body

- Steel - ASTM-A352-GR-LCC

Main Valve Cylinder

- 2" - 4" Stainless Steel on 150 - 600 ANSI
- 6" - 16" Steel, Nickel Coated on 150 - 600 ANSI

Main Valve Piston

- 2" - 16" Stainless Steel standard

Seat Ring

- 2" - 6" Stainless Steel
- 8" - 16" Steel, Nickel Coated standard 150#, 300#, 600#

O-Rings

- Standard - Viton® Dynamic, Buna-N Static
- Optional - Neoprene, EPR, all Viton®, GFLT, all Buna-N, AP (Aggressive Products) Options

Other internal parts: Stainless Steel

- Reservoir - Carbon Steel - ASRM A333
- Cylinder Head - ASTM A516 GR70
- Elbow, Cap, Reducers - ASTM A-350LF2
- Studs and Nuts - A193 Gr BT, 194 Gr 2H

Recommended Spare Parts

- O-rings

Process Parameter

- Temperature Range⁽¹⁾:
-15°F to 400°F (-26°C to 205°C)
Optional 400°F (204°C)
(not available for solenoid operated valves)

Valve Capacity

Valve Capacity								
Valve size	2"	3"	4"	6"	8"	10"	12"	16"
C _v (GPM)	86	186	309	688	1,296	2,040	2,920	5,360

Flange Connections / Ratings (ANSI)			
Valve Size	150 ANSI MWP at 100°F	300 ANSI MWP at 100°F	600 ANSI MWP at 100°F
2" - 16"	285 psi	740 psi	1,480 psi

MWP: Maximum Working Pressure

Flange Connections / Ratings (DIN)						
Valve Size	DIN PN16 MWP at 120°C	DIN PN25 MWP at 120°C	DIN PN40 MWP at 120°C	DIN PN64 (300 ANSI) MWP at 120°C	DIN PN64 (600 ANSI) MWP at 120°C	DIN PN100 MWP at 120°C
DN50 - DN400	16 bar	25 bar	40 bar	51 bar	64 bar	100 bar

MWP: Maximum Working Pressure

⁽¹⁾ Temperature range is dependent on o-ring material T_{min} and T_{max}.

Dimensions - 45° in-line installation

Model 763 Nitrogen Loaded
Back Pressure Control

Model 766 Nitrogen Loaded
Pressure Relief

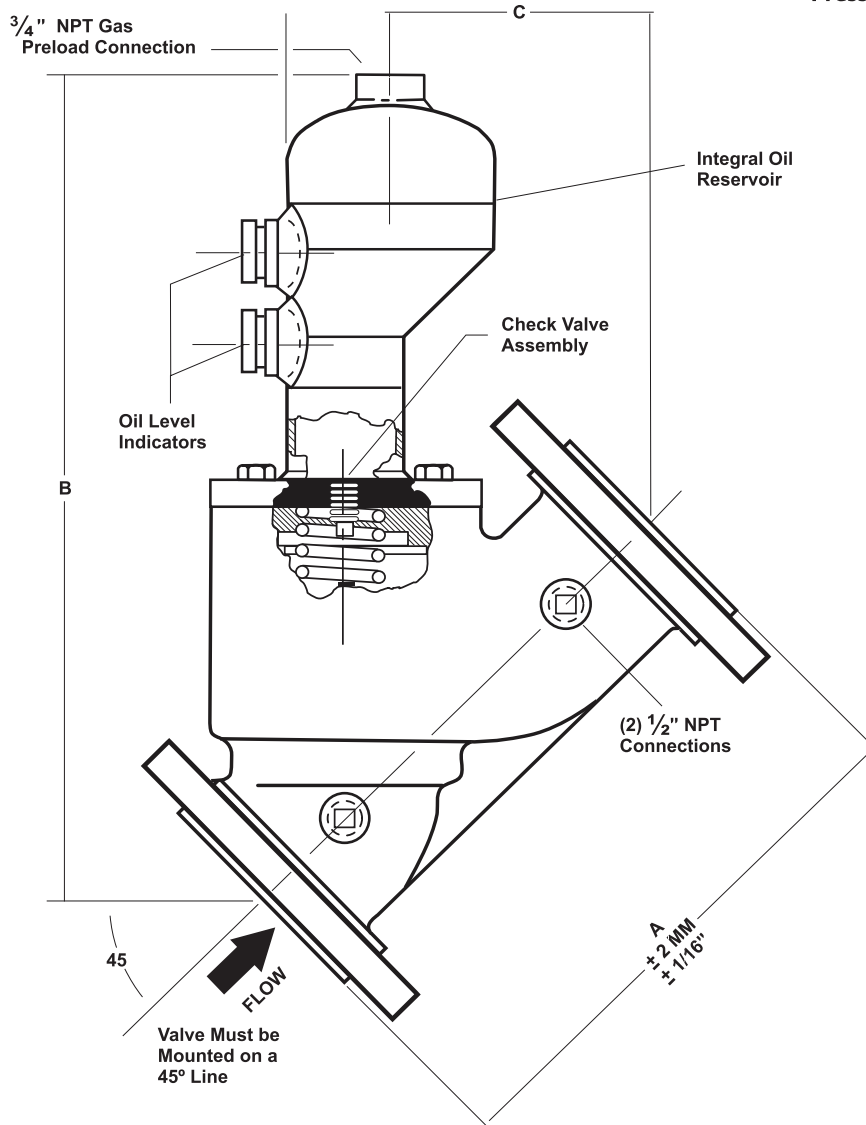

Valve Size	DIMENSION A (ANSI Flanges)						DIMENSION B (ANSI Flanges)						DIMENSION C (ANSI Flanges)					
	150		300		600		150		300		600		150		300		600	
	In	mm	In	mm	In	mm	In	mm	In	mm	In	mm	In	mm	In	mm	In	mm
2"	10 1/4	260	10 1/2	267	11 1/2	292	15 1/2	394	15 1/2	394	16 1/8	410	5 1/2	140	5 3/8	137	5 3/4	146
3"	11	279	13 1/8	333	14	356	18 5/8	473	20 1/4	514	20 1/4	514	5 3/8	137	6 1/4	159	7 1/8	181
4"	13	330	14 1/2	368	17	432	19 1/4	487	19 1/4	502	27 1/2	699	6 3/4	171	7 1/4	184	8 5/8	219
6"	17	432	17 7/8	454	22	559	25 5/8	657	25 7/8	657	27 3/4	705	8 5/8	219	8 3/4	222	10 1/2	267
8"	22 1/4	565	23 1/4	591	26	660	29 7/8	759	30 1/4	768	32 3/4	832	10	254	11 1/4	286	12 5/8	321
10"	26 1/2	673	27 7/8	708	31	787	35 1/4	895	36 1/4	921	39	991	12	305	13 3/8	340	7 1/2	445
12"	30 7/8	784	33 5/8	854	36 1/2	927	42 3/4	1,086	43 5/8	1,108	45 1/2	1,156	15 1/2	394	16 3/4	425	18	457
16"	41 3/8	1,051	43 1/2	1,105	46	1,168	58	1,473	58 3/4	1,492	56 1/4	1,429	20 3/4	527	21 3/4	552	23 3/4	603

Dimensions - 45° horizontal installation

**Model 762 Nitrogen Loaded
Back Pressure Control**

**Model 765 Nitrogen
Loaded Pressure Relief**

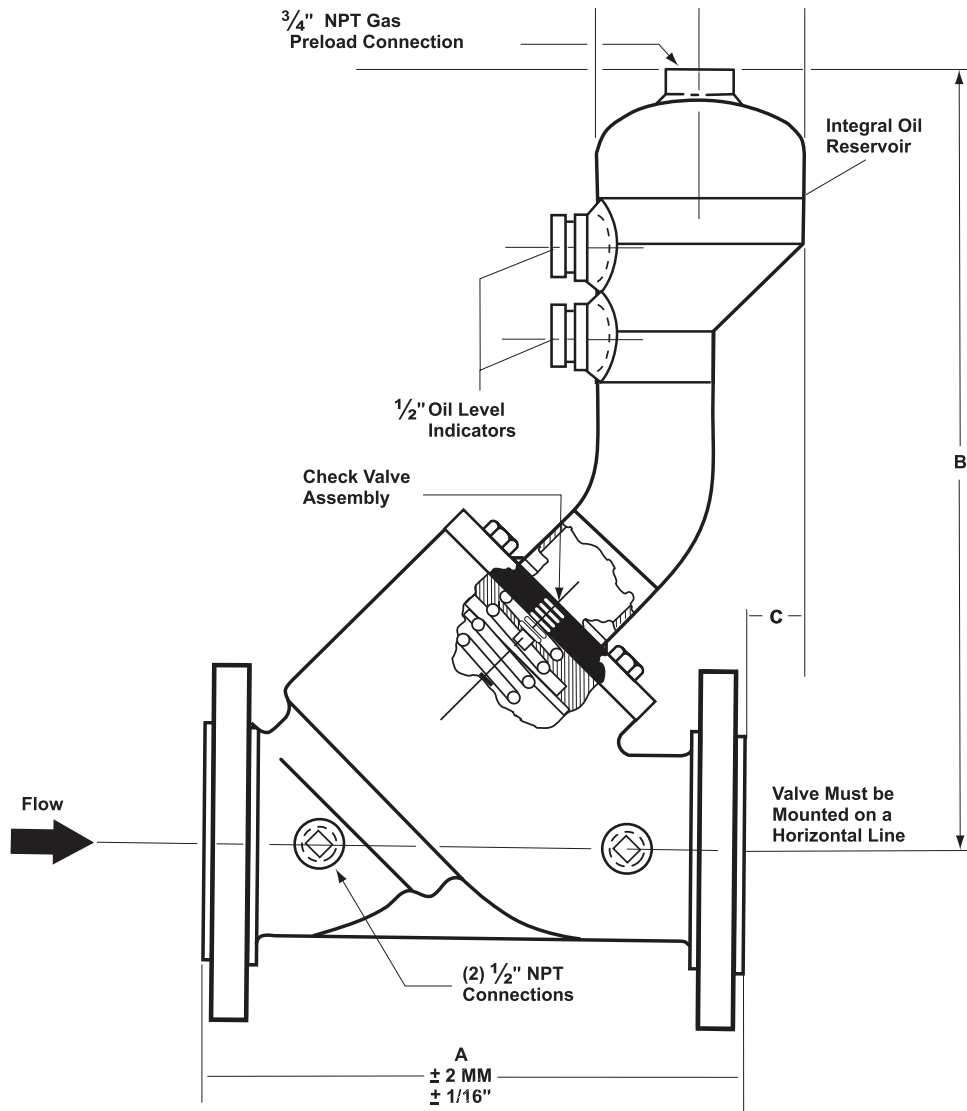

Valve Size	DIMENSION A (ANSI Flanges)						DIMENSION B (ANSI Flanges)						DIMENSION C (ANSI Flanges)					
	150		300		600		150		300		600		150		300		600	
	In	mm	In	mm	In	mm	In	mm	In	mm	In	mm	In	mm	In	mm	In	mm
2"	10 1/4	260	10 1/2	267	11 1/2	292	14 1/8	359	14 1/8	359	14 1/2	368	5/8	16	3/4	19	1/2	13
3"	11	279	13 1/8	333	14	356	16 3/4	425	17 1/4	438	18 3/8	467	2 3/8	60	1 1/2	38	1 1/2	38
4"	13	330	14 1/2	368	17	432	17 5/8	448	17 5/8	470	19 3/8	492	1 1/4	32	1/2	13	1/2	13
6"	17	432	17 7/8	454	22	559	23 3/8	594	23 3/8	606	24 3/8	619	2 3/8	60	2	51	1/4	6
8"	22 1/4	565	23 1/4	591	26	660	27	686	27	714	28 1/8	714	3 3/8	86	1 5/8	41	3/4	19
10"	26 1/2	673	27 7/8	708	31	787	32 1/2	806	31 3/4	806	34 3/4	883	4	102	1 1/2	38	1/2	13
12"	30 7/8	784	33 5/8	854	36 1/2	927	38 3/4	984	38 3/4	1,000	41	1,041	3 5/8	92	2 1/8	54	1 1/8	29
16"	41 3/8	1,051	43 1/2	1,105	46	1,168	52 1/4	1,327	52 1/4	1,327	49	1,245	3 1/4	83	2 1/8	54	CF	CF

Vertical installation

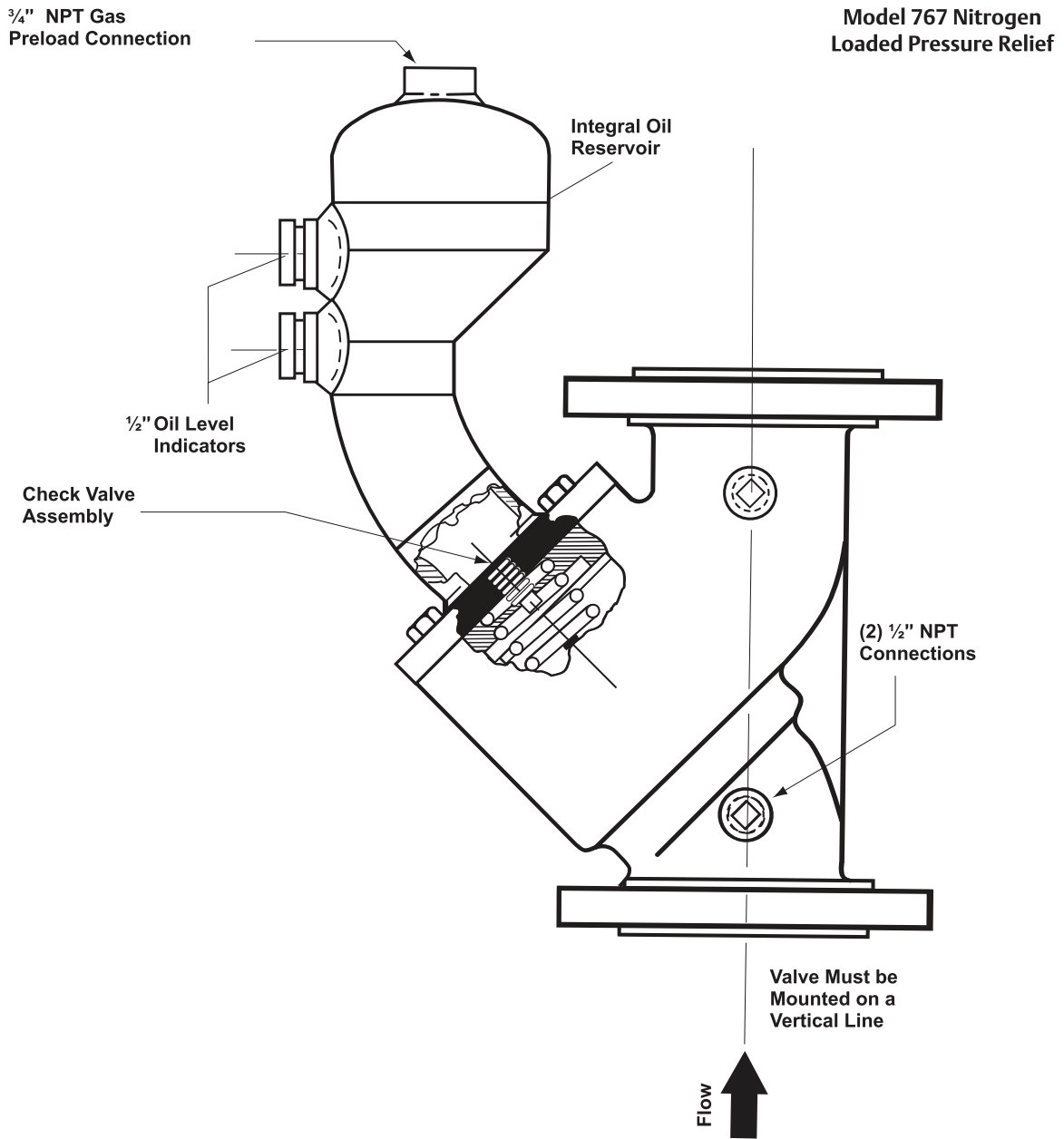

For certified dimension prints of the Model 767, please consult the factory.

Approximate Shipping Weight and Volume								
Valve Size	150 - 300 ANSI				600 ANSI			
	Shipping Weights		Shipping Volume		Shipping Weights		Shipping Volume	
	lbs	Kgs	Cubic Feet	Cubic Meters	lbs	Kgs	Cubic Feet	Cubic Meters
2"	63	29	1.26	0.036	103	47	1.43	0.04
3"	113	51	2.11	0.06	158	72	2.25	0.063
4"	148	67	2.66	0.075	213	97	4.23	0.12
6"	268	122	5.12	0.145	363	165	7.19	0.204
8"	493	224	9.84	0.279	423	192	11.84	0.335
10"	743	337	16.32	0.462	1,225	556	20.45	0.579
12"	1,278	580	26.83	0.76	1,883	854	33.29	0.943
16"	CF	CF	CF	CF	CF	CF	CF	CF

Purchase Specifications

These valves are normally closed and only open when line pressure exceeds the gas loaded bias pressure applied to the integral reservoir of the valve. The gas loaded bias pressure must be equal to the desired set point. There are no unbalanced forces. The integral oil reservoir includes two (2) sight gauges for visual indication of the oil level. Opening and closing speeds are factory set with no external adjustments. The basic valve is a balanced piston design with linear control characteristics. It is a single seated valve with 45° body construction. A major benefit of our valve design is that all internal parts, including cylinder, piston and seat ring are removed as a cartridge assembly which keeps your line connections intact.

Required Ordering Information

- Size
- Product, product viscosity, product specific gravity
- Minimum and maximum operating temperature
- Minimum and maximum flow rate
- Minimum, normal and maximum operating pressure
- Control functions to be performed
- Flange connections (150, 300, 600 ANSI Class)
- O-ring material
- Type of installation (45° in-line, horizontal or vertical)
- Main valve piston material
- Optional equipment

DANIEL 7NL NITROGEN LOADED CONTROL VALVE SELECTION MATRIX

	V	XXX	XX	X	X	X	X	X	X	
Device	↓									
Control Valve	V									
Basic Type / Primary Function		↓								
Nitrogen Loaded Back Pressure Control - Horizontal.....		762								
Nitrogen Loaded Back Pressure Control - Horizontal.....		762								
Nitrogen Loaded Back Pressure Control - Horizontal.....		762								
Nitrogen Loaded Back Pressure Control - Horizontal.....		762								
Nitrogen Loaded Back Pressure Control - Horizontal.....		762								
Line Size			↓							
2" DN50.....			02							
3" DN80.....			03							
4" DN100.....			04							
6" DN150.....			06							
8" DN200.....			08							
10" DN150.....			10							
12" DN300.....			12							
16" DN400.....			16							
Flange Rating / Maximum Working Pressure				↓						
150# ANSI 285 PSI MWP 1,965 kPa MWP				B						
300# ANSI 740 PSI MWP 5,102 kPa MWP				C						
600# ANSI 1,480 PSI MWP 10,204 kPa MWP				D						
PN16 DIN 2526 Form C 16 BAR MWP				H						
PN16 DIN 2526 Form C 25 BAR MWP				K						
PN16 DIN 2526 Form C 40 BAR MWP				L						
PN16 DIN 2526 Form C 64 BAR MWP				N						
PN16 DIN 2526 Form C 100 BAR MWP				P						
Materials of Construction					↓					
Valve Body						↓				
Carbon Steel.....						B				
Low Temp Carbon Steel.....						C				
Nickel Coated Carbon Steel.....						D				
Piston							↓			
Stainless Steel.....							B			
Main Valve Construction								↓		
Standard								B		
Aggressive Product.....								C		
Main Valve Elastomer									↓	
Viton.....									B	
Viton GFLT									C	
Viton V1289-75.....									D	
Viton for LPG Service.....									E	
All EPDM.....									F	
All Neoprene.....									G	
All Nitrile									H	
Teflon Dynamic/ Low Swell Nitrile Static									K	
Kalrez® O-rings									L	
NACE										↓
No.....										A
Yes										B

With over 90 years of experience, Daniel is the only manufacturer that has the knowledge and experience to engineer and offer superior products that are trusted to provide the most reliable and accurate measurements in the global oil and gas industry.

Contact Us

Email: info@daniel.com

Phone: (346) 509-3700

www.daniel.com



Decades Proven. Field Chosen.™